

# **User's Manual**

## **Agilent Technologies 8757D Scalar Network Analyzer**



**Agilent Technologies**

**Manufacturing Part Number: 08757-90122**

**Master Set Part Number: 08757-90109**

**Printed in USA**

**Print Date: November 2000**

© Agilent Technologies, Inc. 2000

---

## **Hewlett-Packard to Agilent Technologies Transition**

This manual may contain references to HP or Hewlett-Packard. Please note that Hewlett-Packard's former test and measurement, semiconductor products and chemical analysis businesses are now part of Agilent Technologies. To reduce potential confusion, the only change to product numbers and names has been in the company name prefix: where a product number/name was HP XXXX the current name/number is now Agilent XXXX. For example, model number HP8648 is now model number Agilent 8648.

---

## **Documentation Warranty**

THE MATERIAL CONTAINED IN THIS DOCUMENT IS PROVIDED "AS IS," AND IS SUBJECT TO BEING CHANGED, WITHOUT NOTICE, IN FUTURE EDITIONS. FURTHER, TO THE MAXIMUM EXTENT PERMITTED BY APPLICABLE LAW, AGILENT DISCLAIMS ALL WARRANTIES, EITHER EXPRESS OR IMPLIED WITH REGARD TO THIS MANUAL AND ANY INFORMATION CONTAINED HEREIN, INCLUDING BUT NOT LIMITED TO THE IMPLIED WARRANTIES OF MERCHANTABILITY AND FITNESS FOR A PARTICULAR PURPOSE. AGILENT SHALL NOT BE LIABLE FOR ERRORS OR FOR INCIDENTAL OR CONSEQUENTIAL DAMAGES IN CONNECTION WITH THE FURNISHING, USE, OR PERFORMANCE OF THIS DOCUMENT OR ANY INFORMATION CONTAINED HEREIN. SHOULD AGILENT AND THE USER HAVE A SEPARATE WRITTEN AGREEMENT WITH WARRANTY TERMS COVERING THE MATERIAL IN THIS DOCUMENT THAT CONFLICT WITH THESE TERMS, THE WARRANTY TERMS IN THE SEPARATE AGREEMENT WILL CONTROL.

---

## **DFARS/Restricted Rights Notice**

If software is for use in the performance of a U.S. Government prime contract or subcontract, Software is delivered and licensed as "Commercial computer software" as defined in DFAR 252.227-7014 (June 1995), or as a "commercial item" as defined in FAR 2.101(a) or as "Restricted computer software" as defined in FAR 52.227-19 (June 1987) or any equivalent agency regulation or contract clause. Use, duplication or disclosure of Software is subject to Agilent Technologies' standard commercial license terms, and non-DOD Departments and Agencies of the U.S. Government will receive no greater than Restricted Rights as defined in FAR 52.227-19(c)(1-2) (June 1987). U.S. Government users will receive no greater than Limited Rights as defined in FAR 52.227-14 (June 1987) or DFAR 252.227-7015 (b)(2) (November 1995), as applicable in any technical data.

---

---

## Printing Copies of Documentation from the Web

To print copies of documentation from the Web, download the PDF file from the Agilent web site:

- Go to <http://www.agilent.com>.
  - Enter the document's part number (located on the title page) in the **Quick Search** box.
  - Click GO.
  - Click on the hyperlink for the document.
  - Click the printer icon located in the tool bar.
-

# Contacting Agilent

This information supersedes all prior HP contact information.

**Online assistance:** [www.agilent.com/find/assist](http://www.agilent.com/find/assist)

Americas			
<b>Brazil</b> <i>(tel)</i> (+55) 11 3351 7012 <i>(fax)</i> (+55) 11 3351 7024	<b>Canada</b> <i>(tel)</i> 888 447 7378 <i>(fax)</i> 905 282 6495	<b>Mexico</b> <i>(tel)</i> 1 800 254 2440 <i>(fax)</i> 1 800 254 4222	<b>United States</b> <i>(tel)</i> 800 829 4444 <i>(alt)</i> (+1) 303 662 3998 <i>(fax)</i> 800 829 4433
Asia Pacific and Japan			
<b>Australia</b> <i>(tel)</i> 1 800 225 574 <i>(fax)</i> 1 800 681 776 <i>(fax)</i> 1 800 225 539	<b>China</b> <i>(tel)</i> 800 810 0508 <i>(alt)</i> 800 810 0510 <i>(fax)</i> 800 810 0507 <i>(fax)</i> 800 810 0362	<b>Hong Kong</b> <i>(tel)</i> 800 933 229 <i>(fax)</i> 800 900 701	<b>India</b> <i>(tel)</i> 1600 112 626 <i>(fax)</i> 1600 112 727 <i>(fax)</i> 1600 113 040
<b>Japan (Bench)</b> <i>(tel)</i> 0120 32 0119 <i>(alt)</i> (+81) 426 56 7799 <i>(fax)</i> 0120 01 2144	<b>Japan (On-Site)</b> <i>(tel)</i> 0120 802 363 <i>(alt)</i> (+81) 426 56 7498 <i>(fax)</i> (+81) 426 60 8953	<b>Singapore</b> <i>(tel)</i> 1 800 275 0880 <i>(fax)</i> (+65) 6755 1235 <i>(fax)</i> (+65) 6755 1214	<b>South Korea</b> <i>(tel)</i> 080 778 0011 <i>(fax)</i> 080 778 0013
<b>Taiwan</b> <i>(tel)</i> 0800 047 669 <i>(fax)</i> 0800 047 667 <i>(fax)</i> 886 3492 0779	<b>Thailand</b> <i>(tel)</i> 1 800 2758 5822 <i>(alt)</i> (+66) 2267 5913 <i>(fax)</i> 1 800 656 336	<b>Malaysia</b> <i>(tel)</i> 1800 880 399 <i>(fax)</i> 1800 801 054	
Europe			
<b>Austria</b> <i>(tel)</i> 0820 87 44 11* <i>(fax)</i> 0820 87 44 22	<b>Belgium</b> <i>(tel)</i> (+32) (0)2 404 9340 <i>(alt)</i> (+32) (0)2 404 9000 <i>(fax)</i> (+32) (0)2 404 9395	<b>Denmark</b> <i>(tel)</i> (+45) 7013 1515 <i>(alt)</i> (+45) 7013 7313 <i>(fax)</i> (+45) 7013 1555	<b>Finland</b> <i>(tel)</i> (+358) 10 855 2100 <i>(fax)</i> (+358) (0) 10 855 2923
<b>France</b> <i>(tel)</i> 0825 010 700* <i>(alt)</i> (+33) (0)1 6453 5623 <i>(fax)</i> 0825 010 701*	<b>Germany</b> <i>(tel)</i> 01805 24 6333* <i>(alt)</i> 01805 24 6330* <i>(fax)</i> 01805 24 6336*	<b>Ireland</b> <i>(tel)</i> (+353) (0)1 890 924 204 <i>(alt)</i> (+353) (0)1 890 924 206 <i>(fax)</i> (+353) (0)1 890 924 024	<b>Israel</b> <i>(tel)</i> (+972) 3 9288 500 <i>(fax)</i> (+972) 3 9288 501
<b>Italy</b> <i>(tel)</i> (+39) (0)2 9260 8484 <i>(fax)</i> (+39) (0)2 9544 1175	<b>Luxemburg</b> <i>(tel)</i> (+32) (0)2 404 9340 <i>(alt)</i> (+32) (0)2 404 9000 <i>(fax)</i> (+32) (0)2 404 9395	<b>Netherlands</b> <i>(tel)</i> (+31) (0)20 547 2111 <i>(alt)</i> (+31) (0)20 547 2000 <i>(fax)</i> (+31) (0)20 547 2190	<b>Russia</b> <i>(tel)</i> (+7) 095 797 3963 <i>(alt)</i> (+7) 095 797 3900 <i>(fax)</i> (+7) 095 797 3901
<b>Spain</b> <i>(tel)</i> (+34) 91 631 3300 <i>(alt)</i> (+34) 91 631 3000 <i>(fax)</i> (+34) 91 631 3301	<b>Sweden</b> <i>(tel)</i> 0200 88 22 55* <i>(alt)</i> (+46) (0)8 5064 8686 <i>(fax)</i> 020 120 2266*	<b>Switzerland (French)</b> <i>(tel)</i> 0800 80 5353 opt. 2* <i>(alt)</i> (+33) (0)1 6453 5623 <i>(fax)</i> (+41) (0)22 567 5313	<b>Switzerland (German)</b> <i>(tel)</i> 0800 80 5353 opt. 1* <i>(alt)</i> (+49) (0)7031 464 6333 <i>(fax)</i> (+41) (0)1 272 7373
<b>Switzerland (Italian)</b> <i>(tel)</i> 0800 80 5353 opt. 3* <i>(alt)</i> (+39) (0)2 9260 8484 <i>(fax)</i> (+41) (0)22 567 5314	<b>United Kingdom</b> <i>(tel)</i> (+44) (0)7004 666666 <i>(alt)</i> (+44) (0)7004 123123 <i>(fax)</i> (+44) (0)7004 444555		
<i>(tel)</i> = primary telephone number; <i>(alt)</i> = alternate telephone number; <i>(fax)</i> = FAX number; * = in country number			

This document is intended to provide an introduction to the operation of the HP 8757D scalar network analyzer. It is organized in a manner that will familiarize the user with many of the capabilities and features of the HP 8757D, illustrating actual operating sequences for various measurements.

Chapter 1 provides a basic introduction to the HP 8757D's front panel, then leads the user through the general measurement procedure for making scalar network measurements.

Chapters 2 and 3 describe the procedure for making transmission and reflection measurements. The examples have been selected to illustrate many of the operating modes of the HP 8757D, and the simplicity of their design. The bandpass filter (HP Part No. 0955-0446) utilized as the device under test in many of the examples, demonstrates the techniques for measuring common devices.

Chapters 4 and 5 describe advanced features, such as limit testing for device evaluation and the alternate sweep capabilities of the HP 8350B, HP 8340B/8341B, and HP 8360 series sources.

Chapter 6 illustrates the HP 8757D's external disk save/recall capabilities, while chapter seven covers special functions such as color selection and frequency blanking. This document also includes an appendix, that describes the capabilities and advantages of the AC and DC detection modes.

The HP 8757D *Operating Manual* has more complete operating information. Use this reference for further information on any topic covered in this User's Guide.

## How to use this guide

To gain the most benefit from this User's Guide, it is recommended that you proceed sequentially through the guide, starting with chapter 1 and ending with chapter 7. Each chapter builds upon the information presented in previous chapters. Also, the examples provided within each chapter are written in procedural form. To follow the examples, start at the beginning of each chapter.

To simplify the execution of the measurements presented, the HP 8757D's front panel "hardkeys" are differentiated from the display "softkeys." The hardkeys are presented in **bold** capital letters (e.g. [CAL]) and the softkeys are *bold italic* capital letters (e.g. [SHORT/OPEN]).

Equipment utilized in this guide

HP 8350B Sweeper with HP83592B RF Plug-in.

Bandpass Filter – HP Part No. 0955-0446.

HP 8447D Amplifier.

HP 85027E Directional Bridge.

Includes 3.5 mm (f) to (f) adapter  
HP Part No. 85027-60005.

and 3.5 mm (f) open/short  
HP Part No. 85027-60004.

HP 11664A Detector.

HP 11664E Detector.

HP 11667A Power Splitter.

HP 8491A 6 dB Attenuator.

HP 8491B 10 dB Attenuator.

HP Part No. 1250-1743.

Type N (m) to 3.5 mm (m) adapter

HP Part No. 1250-1744.

Type-N (m) to 3.5 mm (f) adapter

HP 85022 Cable Kit.

<b>Chapter 1</b>	3	<b>Chapter 6</b>	23
<b>Operating the HP 8757D</b>		<b>External disk save/recall</b>	
Front Panel Tour		Setting Up the Disk Drive	
General Measurement Setup		Intializing a Blank Disk	
Preset		Save/Recall Functions	
Setup Test Connections			
Set System Control Settings		<b>Chapter 7</b>	25
Perform Calibration		<b>Special functions</b>	
Save Instrument State		Color Selection	
Measure Device Under Test		Frequency Blanking	
Output Results			
<b>Chapter 2</b>	10	<b>Appendix</b>	26
<b>Transmission measurements with the HP 8757D</b>		<b>AC versus DC detection</b>	
Basic System Configuration			
Measurement Setup for Insertion Loss and Gain		<b>Index</b>	27
Insertion Loss			
3 dB Bandwidth			
Peak-to-Peak Ripple			
Out of Band Rejection			
Adaptive Normalization			
Measuring Active Devices			
Gain Compression			
<b>Chapter 3</b>	17		
<b>Reflection measurements with the HP 8757D</b>			
Signal Separation			
Device Termination			
Measurement Accuracy			
Measurement Setup for Return Loss and SWR			
Return Loss			
SWR			
<b>Chapter 4</b>	19		
<b>Limit lines</b>			
Accessing the Limit Line Menu			
Creating Limit Lines			
Editing Limit Lines			
Creating Limit Lines for a Bandpass Filter			
<b>Chapter 5</b>	21		
<b>Alternate sweep</b>			

# Operating the HP 8757D

## Front panel tour

The front panel of the HP 8757D was designed to simplify measurement operations. Each “hardkey” accesses a CRT–displayed menu. These menus offer a list of possible selections for the completion of a particular operation. Each selection corresponds to one of the eight “softkeys” located to the right of the display. Using front panel keys to access softkey menus allows for the expansion of the analyzer’s capabilities, without adding front panel complexity.

## CRT display

With the selection of each hardkey or softkey, the HP 8757D’s display is updated to exhibit the current measurement configuration and status information. For those parameters not continually shown on the display, select the appropriate key to exhibit the parameter in the active entry area.

The HP 8757D offers a color display that may be customized to the user’s particular color preferences. A monochrome display mode is also available at the touch of a softkey in the [DISPLAY] menu.

## Mode labels

This area of the CRT is used to show the current status of various functions for the activated channels (an example is shown below). The following table lists the status symbol notations and their meanings.

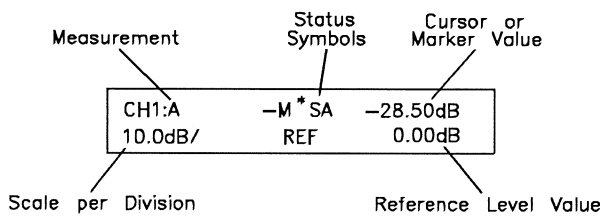

Notation	Definitions
—M	The trace displayed represents the subtraction of the stored data from measured data.
MEM	The trace displayed represents stored data.
S	Trace smoothing is on.
A	Trace averaging is on.
*	Adaptive Normalization is on.
U	Adaptive Normalization is on, but uncalibrated (the frequency span has been increased beyond the original calibration span).

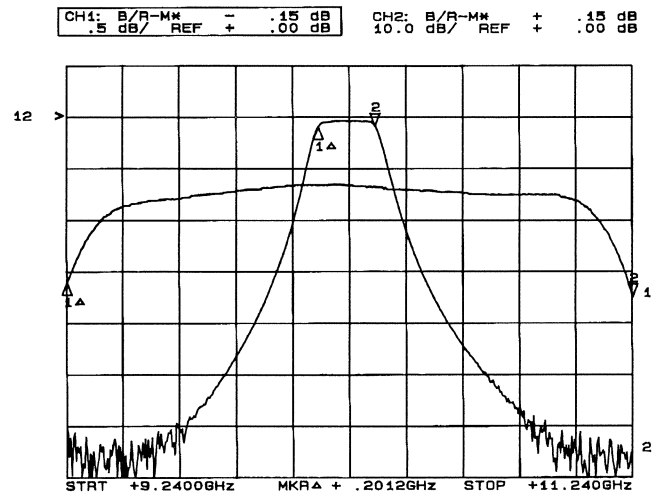

## Channel selection

Many measurement and display functions are independently selectable for each channel. To modify the parameters of a particular trace, first select that channel (making it the active channel), then make the desired measurement choices. The mode label area of the active channel is boxed to differentiate it from other enabled channels.

The HP 8757D may display as many as four channels at one time. A channel may be switched off by pressing the channel hardkey to make it the active channel, then pressing the hard key a second time to turn it off.

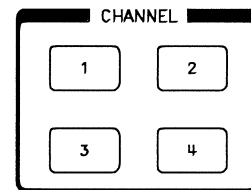

## Function selection

There are eight function keys, which allow the user to select the measurement parameters, calibrate the measurement setup, and manipulate data presentation. [MEAS], [DISPLAY], and [CAL] access menus which provide the user with a choice of measurement and display configurations, and calibration sequences. The [SCALE], [REF], [CURSOR], [AVG], and [SPCL] keys allow the user to manipulate information in a manner that enhances usability of the measured data.

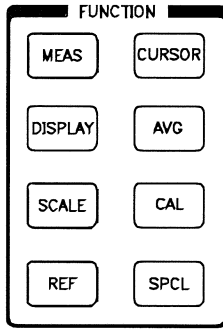

## General measurement sequence

Even with its wide range of capabilities, the HP 8757D is easy to operate. Common measurements can be set up with only a few front panel selections. This section describes a general approach to performing network measurements with the HP 8757D.

The following sequence is used throughout this User's Guide to illustrate the use of the HP 8757D in its various operating modes. The individual steps are discussed in detail in the sections that follow.

### Preset

Return to a known state.

### Connections

Set up the test configuration for your particular device under test.

### Controls

Set up the instrument with the following steps:

1. Select measurement input.
2. Set up source parameters.

### Calibrate

Characterize the systematic errors and remove their effect from the displayed data.

### Save

Save the instrument configuration and calibration to facilitate recalling measurement states.

### Measurement

Measure the performance of the device under test. Utilize the cursor functions to extract key measurement information.

### Output Results

Create a permanent record of your measurement data, by outputting the test results to a plotter or printer. Also, obtain virtually unlimited storage of test setups and measurement data with the HP 8757D and an external disk drive.

## Data entry

The ten digit keypad is used to enter numeric values for a chosen parameter. Once the numbers have been selected, they need to be terminated with the appropriate units located on the right side of the keypad. Use [ENT] to terminate data that is unitless. In addition to entering data with the keypad, the knob may be used to make continuous adjustments, while the [▲] and [▼] keys allow the values to be changed in steps.

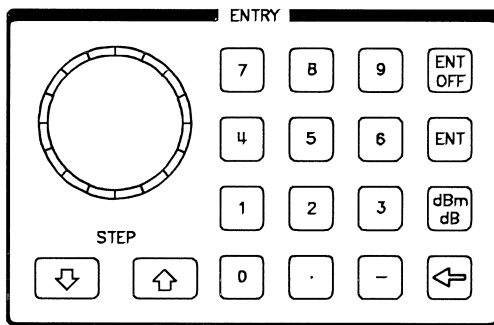

## Instrument state selection

The Instrument State keys control system functions that apply to the entire instrument, they are not channel specific. [SYSTEM], [SAVE], [RECALL], [PRESET], and [LOCAL], implement such functions as: HP-IB plotter, printer, and disk controls, built-in diagnostic tests, front panel save/recall, instrument preset, and HP-IB instrument addresses.

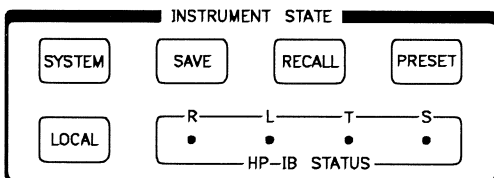



## Step one: preset

Selecting [PRESET] activates a self test routine; when completed, the analyzer returns to a pre-determined state. [PRESET] also initializes all instruments attached to the 8757 System Interface. The major default conditions are listed in the table below.

*Primary default conditions*

Analyzer	
Channel	Channel 1 On, Active Channel 2 On Channel 3 Off Channel 4 Off*
Measurement	A on Channel 1 B on Channel 2 C (Option 001) or B on Channel 3 R on Channel 4
Display format	Displays the current measurement data
Colors	Unchanged
Scale	20 dB/division
Reference	Reference Level equals 0 dBm Reference Position unchanged from previous setting
Number of points	401 trace points
Detection mode	AC
Trace memories	Unchanged
Save/Recall memories	Unchanged
Detector amplitude offsets	Set to 0
Detector frequency offset <sup>1</sup>	Off, start and stop values set to 50 MHz
HP-IB addresses	Unchanged
Cursor	Off Search Value equals -3 dBm
Modulation drive	On
Averaging	Off
Smoothing	Off
Adaptive normalization	Off
Limit lines	Unchanged
<b>Source</b>	
Frequency	Full span of source
Sweep time	200 ms
Modulation	On
<b>Plotter</b>	Abort all activity
<b>Printer</b>	Abort all activity
<b>Disk</b>	Abort all activity

1. Function only available when using the HP 85037 series precision detectors.

## Step two: set up test connections

The device under test (DUT) determines the actual system configuration; the three (optionally four) inputs offer the user a variety of possibilities. Simple insertion loss or gain measurements may be made with only a power splitter and detector. Reflection measurements require a directional bridge or coupler.

The following figure presents a block diagram of a basic scalar coaxial system, configured for ratio reflection and transmission measurements. Adapters, attenuators, isolators, or other components may also be required depending on the actual DUT and the measurement parameters being characterized. Connector savers (high quality adapters) should be utilized whenever possible to preserve test ports of higher cost components (i.e. directional bridges), thus minimizing damage from repeated connect/disconnect cycles.

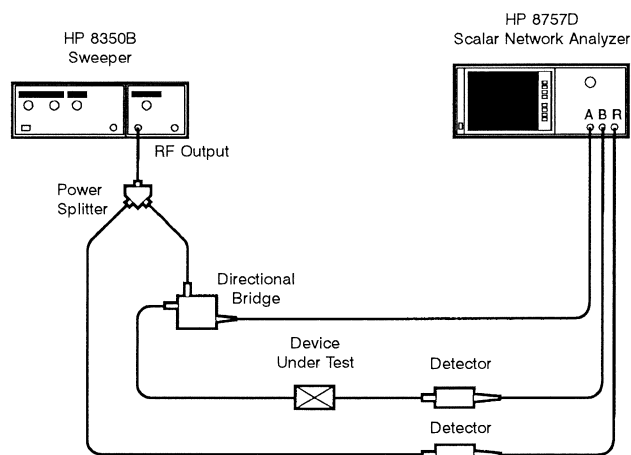

## Step three: set system control settings

1. Select measurement input.
2. Set up source parameters.

Following preset, channel one is active and channel two is on. Use the [MEAS] key to select the appropriate single or ratioed measurement input for characterizing the desired parameters.

Use the controls of the source to set the start and stop frequencies that correspond to the frequency range of the device under test. The 8757 System Interface bus allows the HP 8757D to act as system controller, monitoring source functions. This interface provides frequency annotation on the CRT display, full use of all source marker modes, and control of the analyzer and source preset and save/recall functions. Also, it facilitates full use of the source sweep functions, such as CW (continuous wave), alternate and power sweep modes.

If the DUT is sensitive to the input power level, the power should be measured at the test port of the power splitter or directional bridge. To accomplish this, the device should be removed and the detector attached directly to the test port, then the power level on the source should be adjusted until the desired RF power level appears on the analyzer display. Typically, when the system is connected as in the previous figure, there is a 12 to 14 dB loss in power (from the power splitter and directional bridge) between the output of the source and the output of the test port. Once the power level has been set, reconnect the DUT.

## Step four: perform calibration

Accuracy in network analysis is greatly influenced by factors external to the network analyzer. Parts of the measurement system such as cables, adapters, detectors, and directional bridges all introduce variations that can distort the actual performance of the DUT. For this reason, it is important to start with high quality components in your measurement system as well as ensuring these components are properly cared for. Application Note 326, *Principles of microwave connector care for coaxial system* (HP part no. 5954–1566), provides some valuable care and connection techniques which will help ensure optimum accuracy is obtained from your scalar network analyzer.

In the case of an absolute power calibration, the calibration is not dependant upon the instrument state. Source frequency and power and analyzer measurement settings may be changed without impacting the calibration. For transmission and reflection measurement calibrations, these calibrations are dependant upon the measurement configuration. Only when the adaptive normalization function is activated may the source frequency be changed without invalidating the calibration. Power may be changed if the system is configured for ratio measurements. When new parameters are required, the previous calibration becomes invalid and recalibration must occur.

## Absolute power calibration (HP 8757D option 002 only)

The internal power calibrator in the HP 8757D option 002 is a 50 MHz power transfer standard used to precisely characterize the selected detector's performance from +20 to –50 dBm. While designed specifically for use with the HP 85037 series precision detectors, the power calibrator may also be used with HP's other detectors and directional bridges to obtain optimum absolute power accuracy and dynamic accuracy performance.

**NOTE:** The absolute power calibration must be performed before a transmission or reflection calibration.

### Calibration sequence

[CAL] [MORE]	Accesses calibration menu.
[POWER CAL]	Select power calibration.
[DET B]	Select detector B for calibration. Connect detector B to PWR CAL output. When calibrating a directional bridge, connect the bridge's RF input to the PWR CAL output and connect a short to the test port.
[START CAL]	Executes the power calibration.

The power calibration results will be retained by the HP 8757D option 002 as long as the detector remains attached to the analyzer's input. Once disconnected, the calibration will be lost and a re-calibration required.

### Transmission measurement calibration

For a transmission measurement, a “thru” is the calibration standard. It is accomplished by removing the DUT and directly connecting the measurement test port to the detector, thus establishing a 0 dB loss (or gain) reference.

#### Calibration sequence:

[CAL]	Accesses calibration menu.
[THRU]	Sets up calibration; remove DUT, connect thru.
[STORE THRU]	Stores calibration in memory of active channel.
[DISPLAY]	Accesses display menu.
[MEAS – MEM]	Normalizes measurement trace; subtracts data stored in memory (calibration data) from current measurement data.

## Reflection measurement calibration

Coaxial scalar systems commonly use a short and open as the calibration standards for a reflection measurement. Since either standard reflects all incident power, they provide a convenient 0 dB reference. Mismatches and directivity in the test setup cause calibration and measurement errors that vary as a function of frequency. A test setup with either a short circuit or a shielded open include the same calibration errors 180° out of phase with each other. Therefore, by averaging the responses of a short circuit and a shielded open circuit the mismatch and directivity effects will cancel during calibration, producing an accurate reflection reference. With waveguide scalar measurement systems only a fixed short may be utilized as the calibration standard, since it is impossible to create a full reflection open circuit.

### Calibration sequence:

[CAL]	Accesses calibration menu.
[SHORT/OPEN]	Sets up calibration; connect short.
[STORE SHORT]	Connect open.
[STORE OPEN]	Stores calibration in memory of active channel.
[DISPLAY]	Accesses display menu.
[MEAS-MEM]	Normalizes measurement trace.

## Step five: save instrument state

Utilize the HP 8757D's internal memory or an external disk drive to save/recall the instrument configuration and calibration. This step will save time and effort when reconfiguring frequently used measurement setups or recalling a configuration that was lost after inadvertently pressing [PRESET] or cycling the line power.

## Internal storage

The [SAVE] and [RECALL] keys are used to store and retrieve up to nine complete front panel states of the analyzer and the source (if the 8757 System Interface is connected). Color selections on the HP 8757D may not be saved internally, but may be stored on a disk. Only registers 1 through 4 may store the calibration memory, limit lines, and titles from channels 1 and 2 along with the instrument states. Information may be stored or retrieved internally by selecting [SAVE] or [RECALL], then the number of the storage register. The instrument states are saved in a non-volatile memory, and will not be erased until written over or until the [CLEAR SAV/RCL] softkey is utilized from the [SYSTEM] menu.

## External storage

A permanent copy of the instrument configuration and calibration may be made utilizing the external storage capabilities of the HP 8757D and an external disk drive. The [SAVE] and [RECALL] functions access the external storage menus as well as the internal storage registers. For more information refer to chapter 6, External disk Save/Recall. These external storage capabilities allow the user to increase productivity by concentrating on making measurements, as opposed to repeatedly setting up the same instrument configurations.

## Step six: measure device under test

After the test setup is calibrated, and the device has been connected, the trace displayed will present a normalized measurement of the device being tested.

## Optimizing trace display

To optimize the presentation of data, the scale per divisions, and/or reference level and position may be adjusted. Selecting [SCALE] displays the [AUTOSCALE] softkey which provides a quick convenient method for adjusting these functions. [SCALE] also allows the user to change the scale per divisions by utilizing the keypad, knob, or step keys on the front panel. Reference functions may be adjusted separately by selecting [REF LEVEL], or [REF POSN] from the [REF] menu. Changes may be entered via the keypad, knob, or step keys.

## SWR and AUX display modes

The HP 8757D provides the user a choice of display formats. Reflection measurements may be displayed in standing wave ratio (SWR) or return loss (dB). The default format following preset is return loss. To make measurements in the SWR format select [TRC FMT SWR dB] from the [DISPLAY] menu.

The [AUX] softkey allows the user to measure a voltage incident on the ADC IN connector on the rear panel of the analyzer. This input voltage must be in the -10 to +10V range. The active channel displays this measurement as voltage versus frequency. This function provides a user with the means to measure voltage controlled devices such as attenuators and oscillators, enabling the analysis of the device's output power versus the control voltage. To access the AUX function, select the [MEAS] hardkey and press [MORE] until the [AUX] softkey appears.

## Utilizing cursor and marker functions

The **[CURSOR]** key activates the cursor on all displayed channels. The cursor is identified by a “c” on an inverted triangle above each trace, it remains the active function until one of the other functions or instrument state keys is selected. The cursor value for each trace is presented in the mode label area above the grid. How power is presented is determined by the measurement and display mode selected for each channel; dB represents the difference between two inputs (ratio measurement or current measurement minus the stored reference), whereas dBm represents the absolute power at the chosen input. Use the front panel knob to move the cursor to the desired location on the trace. The measurement value (power and frequency) of the active trace will be displayed in the active entry area of the display.

The cursor menu contains several useful functions that can simplify many measurement procedures, thus reduce measurement times and increase productivity. These features are best illustrated in the transmission and reflection sections (chapters 2 and 3 respectively).

The HP 8757D also has the capability of displaying markers generated by the HP 8350B sweeper and the HP 8340B/8341B and HP 8360 series synthesized sweepers. These sources have independent, continuously variable markers, which may be adjusted via the knob, step keys, or data entry keyboard on the source. The active marker's number is presented on an inverted triangle on top of the displayed traces; other markers are displayed below the traces with their representative marker numbers beneath the triangle.

The markers may be manipulated while the cursor function is on, the cursor will remain active (identified by a “c”) and accessible via the analyzer's front panel. If the cursor is turned off, the active marker's power and frequency will be presented in the mode and the frequency label areas respectively. When the cursor is on, the markers will be visible but without displaying any measurement data. The marker's utility is enhanced by several marker functions, such as marker sweep **[MKR SWEEP]** and marker to center frequency **[MKR→CF]**. A marker difference function **[MKR Δ]**, computes and displays the difference between two markers.

## Step seven: output results

Create a permanent record of the measurement by plotting the results to a plotter or a printer via HP-IB. The plotter/printer buffer facilitates efficient hardcopy outputs of your measurement data, by releasing the analyzer to the user within 5 seconds. Results may also be stored on an external disk. The HP 8757D allows the user to control these external peripherals without connecting an external controller.

To obtain a hard copy output of the current display, selecting **[PRINT]** or **[PLOT]** in the **[SYSTEM]** menu will offer a number of printing and plotting options (displayed in the menus below).

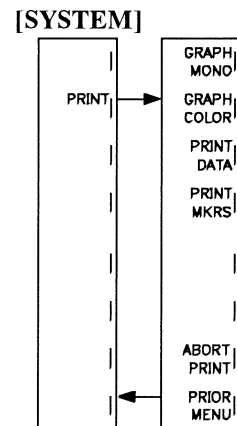
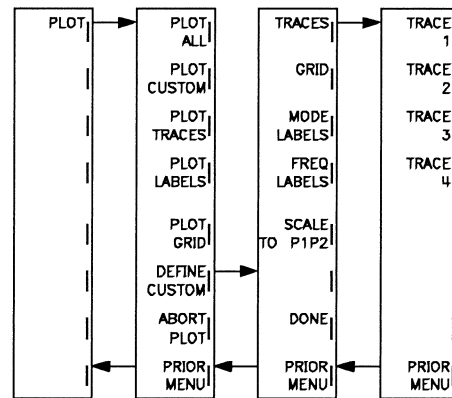

**[PLOT ALL]** plots everything currently displayed except for the softkey menu and the number of points. The user may also choose to plot only specific parameters (i.e. **[PLOT TRACES]** ...), or if repeated plots utilizing the same display parameters are necessary, a custom plot may be specified. **[DEFINE CUSTOM]** allows the user to select the display parameters for custom plots, then selecting **[PLOT CUSTOM]** will output the results with the same format each time. The **[SCALE TO PIP2]** option in the **[DEFINE CUSTOM]** menu allows the user to expand the plot to fill up the page, in this case the labels are plotted inside the grid.

In the HP 8757D's **[PRINT]** menu, **[GRAPH MONO]** allows the user to print the displayed information to any compatible printer in black and white. **[GRAPH COLOR]** may only be utilized with a HP PaintJet (color) printer. Both of these functions will output everything displayed except for any messages in the display's active entry area and the softkey menu.

Selecting **[LABELS]** in the **[SYSTEM]** menu offers the user the choice of turning on or off the labels or title of the current display prior to printing. **[PRINT DATA]** will output each point on the trace in tabular form. **[PRINT MARKERS]** will list just the information relating to markers and cursors currently displayed.

## Transmission measurements with the HP 8757D

This chapter demonstrates many of the features of the HP 8757D. A complete measurement setup is given for each example, following the same basic measurement sequence of chapter one. The examples provided in this document represent typical scalar network measurements. This section describes transmission measurements of insertion loss, 3 dB bandwidth, peak-to-peak ripple, and gain compression. Some of the features presented are: averaging, smoothing, adaptive normalization and power sweep.

Modify the instrument setups shown to suit your particular needs. For further information on any of the measurements shown, refer to the appropriate operating manual for the most complete description of the analyzer's operating modes, parameters, etc.

### Basic system configuration

The HP 8757D analyzers can measure transmission using any of the four display channels with either a single detector at input A, B, C (HP 8757D Option 001) or R, or two detectors in a ratio measurement (i.e. A/R, B/R, etc.). In the simplest transmission setup the device attaches directly to the source, and the detector to the output of the device. This configuration will produce accurate results when a leveled source is utilized with a low reflection test device. However, when source mismatches occur they can create power level variations which will produce system errors.

Ratioing provides an improvement in effective source match by eliminating the effects of source power variations common to both reference (R) and test inputs. This technique is particularly appropriate for measurement of devices with a low insertion loss, poor input match, or an unlevelled source. Since active devices (devices with gain) usually require measurements with varying inputs, ratioing eliminates the need to recalibrate each time the power level is changed; also it reduces the ripple associated with source mismatches to which many active devices are particularly sensitive.

### Measurement setup for insertion loss and gain

Insertion loss and gain are ratios of the output to input signals. When set up as shown below, the results can be read directly in decibels (dB).

#### Preset

Return the system to a known state, channel 1 active.

#### Connections

Connect the DUT to the network analyzer as shown in the previous configuration.

#### Controls

Setup the measurement.

#### Measurement

- [MEAS] [B/R] Sets up ratio measurement on channel 1.
- CHANNEL [2] Activate channel 2
- CHANNEL [2] Turn channel 2 off. Channel 1 becomes active channel.

#### Source parameters

- [CF] Activates the center frequency function.
- [10.24] [GHz] Sets center frequency to 10.24 GHz.
- [ΔF] Activates frequency span function.
- [2] [GHz] Sets frequency span to 2 GHz.
- [POWER LEVEL] Activates power level function.
- [10] [dBm/dB] Sets power level to +10 dBm.

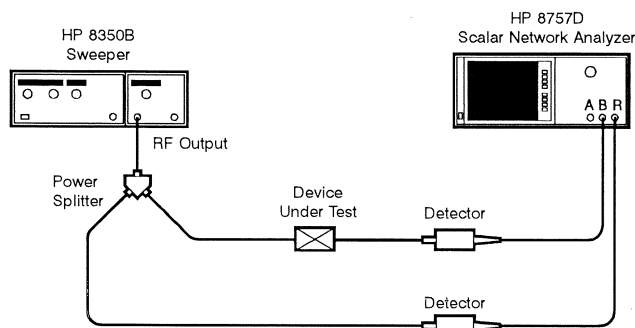

## Calibrate

Perform thru calibration.

<b>[CAL]</b>	Accesses calibration menu.
<b>[THRU]</b>	Sets up calibration; remove DUT, connect thru.
<b>[STORE THRU]</b>	Stores calibration in active channel's memory.
<b>[DISPLAY]</b>	Accesses display menu.
<b>[MEAS-MEM]</b>	Normalizes measurement trace.

## Save

Save the instrument states and calibration.

<b>[SAVE]</b>	Presents "SAVE REG" in the display's active entry area.
<b>[1]</b>	Saves instrument state and calibration in register 1.

## Measurement

Reconnect the DUT.

<b>[SCALE]</b>	Activates scale function.
<b>[AUTOSCALE]</b>	Provides quick, convenient scaling of the measurement data.

Raising the reference position to the top half of the grid and adjusting the reference level to 0 dB sets the passband of the filter to the reference line, facilitating average insertion loss measurements and magnifying the passband region for flatness measurements without resetting the reference levels. The following sequence sets up the reference functions:

<b>[REF]</b>	Activates reference level function and displays menu.
<b>[REF POSN]</b>	Allows the user to change the position of the reference line.
<b>[▲] or [▼]</b>	Steps the reference line up or down to any of the major graticules.
<b>[REF LEVEL]</b>	Allows the user to change the position of the trace relative to the position of the reference line.
<b>[0] [dBm/dB]</b>	Sets the reference level to 0 dB.

The following figure shows the complete transmission response of the bandpass filter under test. The display exhibits several important filter parameters. The cursor functions provide a powerful tool for measuring specific points or the difference between two points. Note that the cursor value is displayed in the mode label area above the reference level value; the negative value indicates loss, a positive value would indicate gain.

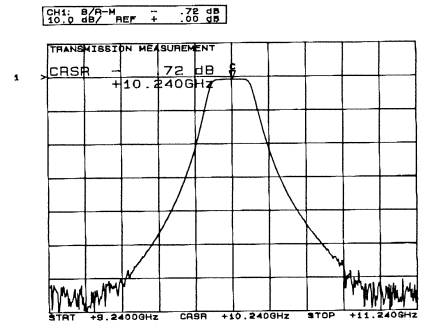

## Insertion loss

Insertion loss can easily be determined to 0.01 dB resolution, by utilizing the cursor to measure the magnitude at any frequency of interest. When the cursor is active, the magnitude and frequency of that point will be presented in the active entry area of the display.

Average insertion loss is determined by utilizing the scale and reference level functions to magnify the passband, and making the ripple symmetrical about the reference line.

<b>[SCALE]</b>	Activates the scale function.
<b>[0.2] [dBm/dB]</b>	Sets scale to 0.2 dB/division.
<b>[REF]</b>	Accesses reference menu.
<b>[REF LEVEL]</b>	Activates reference level function; use the front panel knob to move the trace such that the ripple is symmetrical about the reference line; read the average insertion loss in the active entry area of the display.

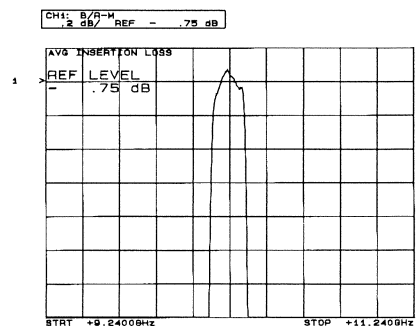

When finished, reset the reference level to 0 dB for the following measurements.

## 3 dB bandwidth

On the HP 8757D, bandwidth measurements are accomplished by selecting *[MAX]*, *[CURSOR Δ ON OFF]*, then moving the trace cursor to one side of the bandpass filter and locating the  $-3$  dB point. Determine the frequency at that point, by turning *[CURSOR Δ ON OFF]* and noting the cursor value. Repeat the process to find the  $-3$  dB point on the other side of the passband, then manually compute the bandwidth.

The HP 8757D's cursor search functions allow the user to determine the 3 dB bandwidth with only a few key-strokes.

<i>[SCALE]</i>	Activates scale function.
<i>[AUTOSCALE]</i>	Scales traces.
<i>[CURSOR]</i>	Turns cursor on, activates menu.
<i>[SEARCH]</i>	Activates search menu, displays current search value, default value equals $-3$ dB.
<i>[BANDWIDTH]</i>	Places cursor markers on the $-3$ dB points of trace, displays search value and bandwidth frequency span.

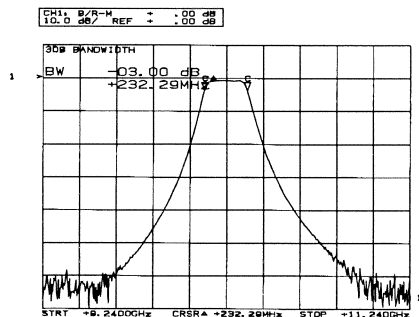

The search value and the bandwidth value are the same. To change the bandwidth value, select *[SEARCH]*, *[SEARCH VALUE]*, and enter the number on the keypad, followed by *[ENT]*. The user may also require frequency information at specific points. Selecting *[MAX]*, then *[CURSOR Δ ON OFF]*, *[SEARCH]*, and *[SEARCH RIGHT]* or *[SEARCH LEFT]* will move the cursor to the "search value" previously set. Then selecting *[CURSOR Δ ON OFF]* will display the frequency at that point.

## Peak-to-peak ripple

Measuring peak-to-peak ripple requires magnifying the passband such that the difference between the peaks can be determined.

<i>[SCALE]</i>	Activates scale function.
<i>[0.2] [dBm/dB]</i>	Sets scale to 0.2 dB/division.
<i>[CURSOR]</i>	Activates cursor function.
<i>[MAX]</i>	Moves cursor to maximum point on trace.
<i>[CURSOR Δ ON OFF]</i>	Marks the cursor position; use the front panel knob to move the cursor to the minimum point on the trace, the active entry area of the display will present the magnitude (and frequency) of the difference between the two points.

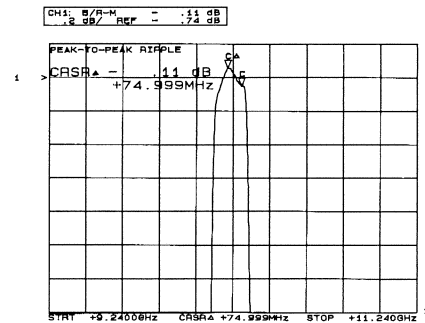

If more resolution is desired in the peak-to-peak measurement, the user may zoom in on the passband by selecting channel 2, then repeating the general measurement setup for channel 1, except replacing the *[ΔF]* with the span of the passband.

## Out of band rejection

The wide dynamic range of the HP 8757D allows it to measure stopband rejection over 76 dB below the passband response. Maximum dynamic range requires proper selection of the measurement port power level and averaging factor. The *[MAX]* and *[MIN]* functions in the cursor menu allow the user to quickly determine the dynamic range of the device under test.

Usable dynamic range is the difference between the measurement port's output power and the HP 8757D's noise floor. Optimizing dynamic range therefore involves:

- choosing the optimum input and output power to the device.
- reducing the analyzer's noise floor.



## Selecting the power level

The accompanying figures show how power test levels determine the available measurement range. In the first case, the output power of the source is  $-5$  dBm. The device appears to have approximately 50 dB of rejection in the stopband. In the second case, the output power of the source is  $+10$  dBm. Notice, this increases the measurable dynamic range to  $>65$  dB. We have now demonstrated that the stopband rejection of this device is  $>65$  dB.

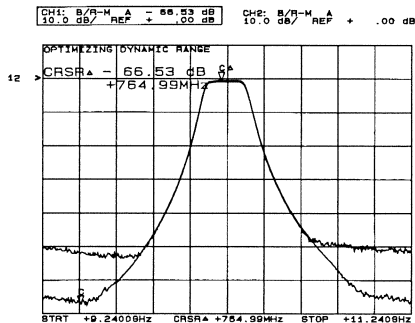

The user should ensure that the DUT's output power is within the measurement range of the analyzer. The analyzer can measure signals up to  $+20$  dBm with the HP 85037 series precision detectors, and to  $+16$  dBm with the HP 11664 and HP 85025 series detectors. On the low end, the analyzer can measure signals down to  $-60$  dBm with the HP 11664 series and to  $-55$  dBm ( $-50$  dBm in DC mode) with the HP 85037 and 85025 series detectors.

When  $>80$  dBm of dynamic range is required, Application Note 327-1 describes how to utilize a HP 8349B Amplifier and an external leveling loop to extend the dynamic range of your measurement system.

## Averaging

Averaging can reduce random noise measured by the HP 8757D, by applying weighted averaging to successive traces. The averaging factor *[AVG FACTOR]* determines the number of sweeps over which the traces are averaged. This function improves the accuracy and resolution of the calibration and measurement traces. When averaging is on, each successive sweep flattens the noise floor of the analyzer until the sweep count reaches the averaging factor value. Users must be careful to adjust the device under test only after the averaging of the traces has settled and the value of the averaging factor has been reached. An "A" will be displayed in the center of the channel's mode label area when averaging is in use.

### Averaging keystrokes

<b>[AVG]</b>	Accesses averaging menu.
<b>[AVG ON OFF]</b>	Turns averaging on.
<b>[AVG FACTOR]</b>	Displays current averaging factor value in active entry area, default value is 8; the value may be changed via the keypad, knob or step keys.
<b>[RESTART AVERAGE]</b>	Restarts the averaging algorithm.
<b>[AVG ON OFF]</b>	Turns off averaging function.

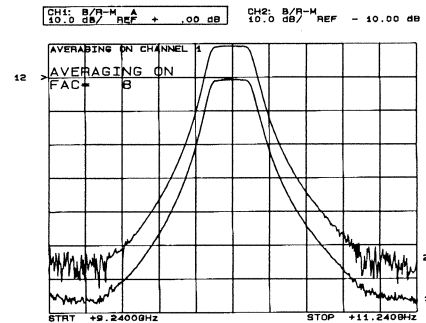

## Smoothing

Although smoothing does not lower the noise floor, it can make noisy signals easier to interpret by reducing trace ripple. Smoothing is often likened to video filtering, and is different from averaging. Averaging computes each data point based on the average value during several sweeps. Smoothing computes each data point based on one sweep, but on the average of a window of several data points for the current sweep. The window or smoothing aperture is a percent of the swept frequency span, less than or equal to 20%.

Use smoothing with caution; too large a smoothing aperture may distort the data. The trace on channel 2 shows the response of a bandpass filter with no smoothing. The channel 1 trace shows the response with 1% smoothing. For this example, the 1% smoothing reduces the noise seen in the filter's reject band. Increasing smoothing beyond 1% will visibly distort the passband response. Notice the "S" in the mode label area indicating that smoothing is active for channel 1.

### Smoothing keystrokes

[SPCL]	Accesses the special functions menu.
[SMOOTH ON OFF]	Turns smoothing on.
[SMOOTH APERT]	Allows the smoothing aperture to be changed; the default value is 5%.
[SMOOTH ON OFF]	Turns smoothing off.

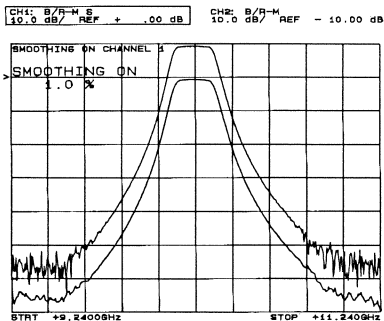

## Adaptive normalization

This feature allows the user to reduce the frequency span of a measurement without having to recalibrate. Note that the resolution (the number of points) of the narrower frequency span is not changed as the trace is expanded. This function utilizes the calibration data stored in memory and interpolates between the original calibration points.

Adaptive normalization is only available for normalized traces (MEAS—MEM) or if MEM is selected in the display menu. An asterisk (\*) is displayed in the mode label area when adaptive normalization is active. If the frequency span is increased beyond the original calibration span, the measurement becomes uncalibrated and the \* is replaced with a U in the mode label area.

The following sequence demonstrates how to use the adaptive normalization function of the HP 8757D, and the marker functions of the HP 8350B sweeper and HP 8340B/8341B synthesized sweepers to expand and display a selected portion of a calibrated trace.

[SYSTEM]	Displays system menu.
[ADPT NRM ON OFF]	Activates adaptive normalization function; select prior to changing the frequency settings.
[M1]	Activates marker 1; enter the start frequency on the source via the knob above the marker key or the keypad.
[M2]	Activates marker 2; enter the stop frequency on the source.
[SHIFT] [M1]	Activates the source's marker Δ function; displays the amplitude and frequency differences in the mode label area and beneath the grid respectively.
[MKR SWEEP]	Displays an expanded trace which is swept from marker 1 to marker 2; changes the source's front panel settings to reflect the new frequency span.

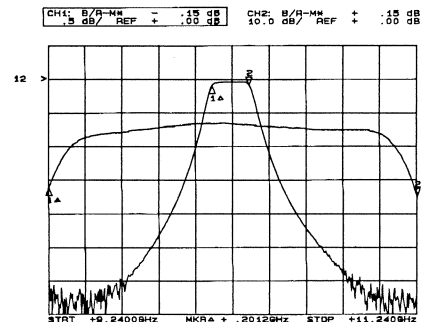

For other examples utilizing adaptive normalization, refer to the gain compression measurement section or chapter 5 (Alternate Sweep).

# Measuring active devices

Active devices (devices with gain), usually require measurement at varying input power levels; a ratio configuration offers the best measurement results. Generally, the test setup for measuring gain and insertion loss are very similar. Although, it will be necessary to add attenuators to the measurement system if the input power to the detector exceeds +20 dBm. When an active device has a large gain, the input power needs to be appropriately attenuated during calibration and measurement.

When testing a modulation-sensitive device, the DC detection mode must be utilized. The HP 85025 series detectors operate in both AC and DC detection modes. The AC/DC mode softkey is located in the [SYSTEM] menu. Selecting [MODE AC DC] will turn off the square wave signal on the source and set the HP 85025 series detectors to DC mode. See the appendix for more information on AC versus DC detection.

## Gain compression

Measurement of gain compression is useful for characterizing the power handling capability of active devices such as amplifiers. The 1 dB compression point of an amplifier is an indicator of the maximum output power possible before the gain non-linearity and its associated distortion becomes excessive. Measurements to this point have all been made with a constant input amplitude and swept test frequency. Gain compression measurements may be made in CW (single frequency) or swept modes. For the most accurate measurement at a particular frequency the source's power sweep mode may be utilized. This allows the user to characterize a device at a CW frequency as a function of input power.

The following sequence the power sweep function to measure gain compression.

### Preset

Return the system to a known state, channel 1 active.

### Connection

Utilize the insertion loss measurement configuration. Add attenuation where appropriate.

### Controls

Setup the measurement.

### Measurement

[MEAS] [B/R]	Sets up channel 1 for gain measurement.
CHANNEL [2] [MEAS] [B]	Activates channel 2. Sets up absolute output power measurement on channel 2.
[CHANNEL 4] [MEAS] [R]	Activates channel 4. Sets up absolute input power measurement.

### Source parameters

[SHIFT] [CW]	Sets up display for gain and power versus input power at one frequency; set to desired frequency in amplifier range.
[POWER LEVEL] [POWER SWEEP]	Set start power. Enter the sweep range required to saturate the amp; e.g. 10 dB per sweep.

In the [SHIFT] [CW] mode, the source's SWEEP OUT drives the horizontal axis of the HP 8757D display to make this axis power instead of frequency.

## Calibrate

Whereas the HP 8757D will require a thru calibration (channel 1) only once for the full range of the amplifier under test, then the adaptive normalization function may be utilized to adjust the calibration data to the selected CW frequency. The thru calibration required is described in the insertion loss and gain measurement setup section. The adaptive normalization function needs to be selected prior to the selection of the CW frequency, as shown below:

[SYSTEM] [ADPT NRM ON OFF]	Accesses system menu. Activates adaptive normalization function.
-------------------------------	---

### Source parameters

[SHIFT] [CW]	Enter desired frequency.
[POWER LEVEL]	Set start power.
[POWER SWEEP]	Enter sweep range.

## Save

Save the instrument states and calibration as previously described.

## Measurement

Reconnect the DUT.

Select channel 1 if it is not active. The cursor function should be utilized to find the maximum point on the trace. Then by activating the cursor  $\Delta$  function the 1 dB point may be located, either by rotating the front panel knob or by utilizing the search function of the HP 8757D and changing the search value to  $-1$  dB. When the search function on the HP 8757D is used, and the 1 dB compression point has been located, selecting the cursor hardkey turns off the delta cursor function so that the absolute output and input power levels are presented in the mode label areas of channels 2 and 4 respectively.

Most HP 8350B RF plug-ins in the power sweep mode can sweep up to 15 dB from the initial power set with [POWER LEVEL]. If the 1 dB compression point cannot be found, increase the power sweep setting or the start power. Remember not to exceed the maximum input power of the detector ( $+20$  dBm), use attenuators where appropriate.

Once the measurement has been completed, a new frequency may be chosen. A convenient way to accomplish this is to set a step size in GHz, and increment the frequency by selecting [SHIFT] [CW] [ $\blacktriangle$ ]. It is not normally necessary to adjust the power sweep parameters once they are set up. However, the sweeper must remain in CW mode.

The following figure displays gain and the absolute input and output power at 1 dB compression for a HP 8447D Amplifier. Channel 1 was calibrated across the 100 MHz to 1.5 GHz frequency range. The plug-in power level was set to  $-4$  dBm, with a 10 dB and 6 dB pad attached to the output. The other measurement parameters may be determined from the figure.

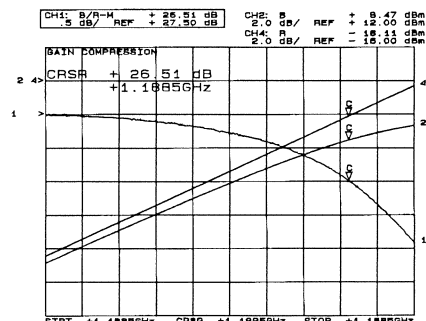

For more information on scalar analysis of amplifiers and mixers, refer to Application Notes 345-1 and 345-2 respectively.

## Reflection measurements with the HP 8757D

The transmission measurements discussed in chapter 2 are only part of the network measurements picture. Measuring the return loss or SWR completes the device characterization. This chapter demonstrates how to perform reflection measurements with the HP 8757D.

### Signal separation

Reflection measurements require the separation of the signal incident upon the input of the device from the device's reflected power. A signal separator such as a directional bridge or coupler provides a sample of the power traveling in only one direction; when it is connected as shown in the figure below, the reflected power is separated and measured independently of the incident power. Many types of directional bridges and couplers are available. They are differentiated by frequency range, directivity and connector type.

### Device termination

Reflection measurements involve only one port of a test device. When a device has more than one port, it is critical that all of the unused ports are properly terminated in their characteristic impedance (e.g. 50 or 75 ohms). High quality loads or detectors with excellent return loss (such as the HP 85025E) should be used whenever possible, particularly with low loss devices. Otherwise, reflections off the unused ports will cause measurement errors.

### Measurement accuracy

In reflection measurements, the accuracy of the final result is highly dependent on the signal separation devices, adapters, and the DUT terminations. Systematic errors such as the frequency response of the test setup, directivity, and mismatches degrade overall measurement accuracy. The HP 8757D's calibration routines can significantly reduce these measurement errors.

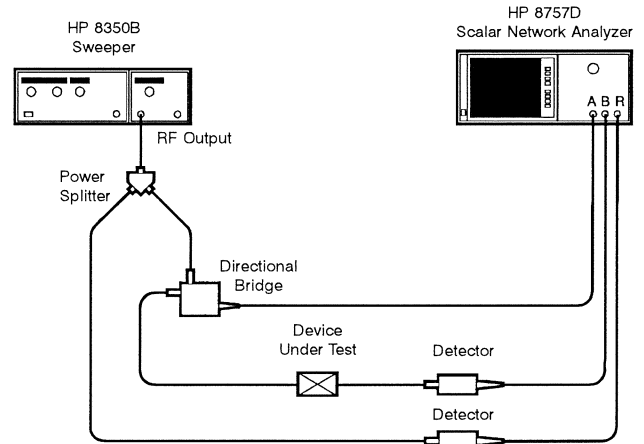

## Measurement setup for return loss and SWR

The signal reflected from the DUT is most often measured as a ratio with the incident signal and can be expressed as return loss or SWR (standing wave ratio). These measurements are mathematically defined as:

$$\text{reflection loss} = \text{reflected/incident} = \rho.$$

$$\text{return loss (dB)} = -20 \log \rho.$$

$$\text{SWR} = (1 + \rho) / (1 - \rho).$$

### Preset

Return the system to a known state, Channel 1 active.

### Connections

Connect DUT as shown in figure.

### Controls

Setup instrument.

#### Measurement

- CHANNEL [2] Activates channel 2.
- CHANNEL [2] Turns channel 2 off, activates channel 1.
- [MEAS] [A/R] Sets up reflection measurement on channel 1.

#### Source parameters

- [CF] [10.24] [GHz]
- [ΔF] [2] [GHz]
- [POWER LEVEL] [10] [dBm/dB]

## Calibrate

Perform reflection calibration.

[CAL]	Accesses calibration menu.
[SHORT/OPEN]	Sets up calibration; connect short.
[STORE SHORT]	Connect open.
[STORE OPEN]	Stores calibration in memory of active channel.
[DISPLAY]	Accesses display menu.
[MEAS-MEM]	Normalizes measurement trace.

## Save

[SAVE] [2]	Save instrument state and calibration in register 2.
------------	--

## Measurement

Reconnect DUT and adjust parameters to enhance usability of measurement data.

## Return loss

The following figure displays the return loss of the band-pass filter. Since the return loss is high in the passband of the filter, only a small portion of the incident signal is being reflected off the filter. This indicates a good match between the filter and the test system impedance. The return loss in the filter's reject band is approximately 0 dB, which corresponds to an almost full reflection of the incident signal. A good passband filter should transmit the signal in the passband (i.e. small reflection, high return loss), while rejecting all signals outside of the passband (i.e. high reflection, low return loss).

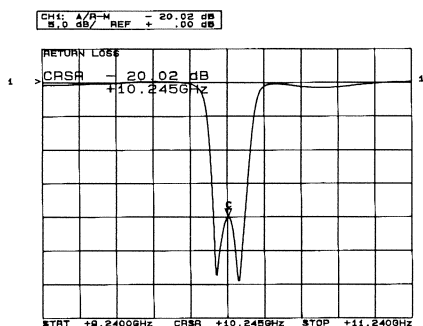

## SWR

To display reflection data in terms of SWR, select [DISPLAY] then the [TRC FMT SWR dB] softkey. SWR is a unitless value, a SWR=1 corresponds to no reflection (perfect match), while an infinite SWR corresponds to 100% reflection (poor match). SWR is only available for ratioed or normalized measurements.

## Simultaneous transmission and reflection measurements

Simultaneous insertion loss and return loss measurements are useful when adjusting the impedance match of a device for maximum power transfer. With the HP 8757D these measurements are easily accomplished. The following sequence demonstrates this feature.

## Preset

Return the system to a known state, channel 1 active.

## Connections

Connect DUT as shown.

## Controls

### Measurement

[MEAS] [A/R]	Sets up channel 1 for reflection measurement.
CHANNEL [2]	Activates channel 2.
[MEAS] [B/R]	Sets up channel 2 for transmission measurement.

### Source parameters

[CF] [10.24] [GHz]
[ΔF] [2] [GHz]
[POWER LEVEL] [10] [dBm/dB]

## Calibrate

Perform an open/short calibration on channel 1 and a thru calibration on channel 2.

## Save

## Measurement

Reconnect the DUT.

Adjust traces for the best data presentation with function keys.

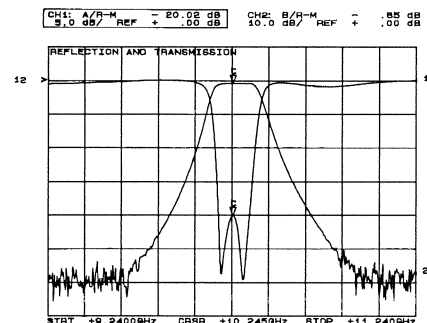

## Limit lines

Limit testing is a measurement technique that compares measurement data to user defined constraints. Depending on the results of this comparison, the HP 8757D will display either pass or fail above the grid. Limit testing facilitates objective evaluation of your device's performance. Determining whether a filter meets its passband and stopband specifications or an amplifier meets its minimum gain specification is easily achieved utilizing limit lines that provide quick, convenient, and repeatable results. Limit testing also ensures that all devices are aligned and tested to the same specifications at each measurement station.

Limit testing is implemented by creating any combination of flat, sloping, and/or single point limit lines on the HP 8757D's display. Limit lines are defined in terms of upper and lower specifications for a particular frequency or band of frequencies. When combined, these lines represent the performance constraints of the device under test. Up to 12 limit segments are available for channels 1 and 2. They may be stored in the analyzer's internal save/recall registers 1 through 4. The following sequences will describe how to create each type of limit line and the sequence for the measurement of the passband filter previously shown.

### Accessing the limit menu

- [SPCL]      Accesses the special functions menu.
- [LIM LNS ON OFF]      Turns on the limit line function.
- [ENTER LIM LNS]      Accesses the limit line menu.

### Creating flat limit lines

- [FLAT LIMIT]      Sets up the flat limit function.
- [10.1] [GHz]      Enters start frequency for first segment.
- [1] [dBm/dB]      Enters upper limit.
- [—2] [dBm/dB]      Enters lower limit.
- [10.3] [GHz]      Enters stop frequency.

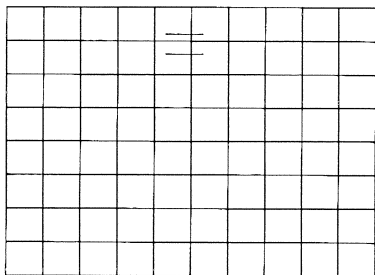

Flat limit lines are useful for testing insertion loss and passband ripple. The limit lines of the first segment should be displayed as soon as the stop frequency is entered. Once the first segment has been entered, the user may choose to start another segment by selecting the limit line type or terminate the limit line selection process by selecting [DONE]; the [SPCL] menu will reappear.

### Creating sloped limit lines

- [SLOPE LIMIT]      Sets up the slope limit function.
- [9.25] [GHz]      Enters start frequency of segment.
- [—44] [dBm/dB]      Enters start position of upper limit.
- [—50] [dBm/dB]      Enters start position of lower limit.
- [10.1] [GHz]      Enters stop frequency of segment.
- [1] [dBm/dB]      Terminates the upper limit line.
- [—5] [dBm/dB]      Terminates the lower limit line.

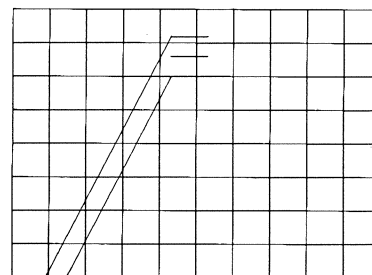

The user may find it difficult to span the entire side of a bandpass filter with one segment since the slope is not constant from the passband to the noise floor. It may be easier to set up the limit lines for one side with two segments (shortening the span) or, the user has the option of entering the limit lines for the entire span as two separate segments, one upper and one lower. To produce just an upper limit, the user may select [ENT] for the lower limit values of the start and stop frequencies.

\*Available only on the HP 8757D. To deactivate a channel on the HP 8757E, press its hardkey until the channel turns off.

# Creating point limits

- [POINT LIMIT] Sets up the point limit function.
- [10.4] [GHz] Enters the point's frequency.
- [1] [dBm/dB] Enters upper point position.
- [-2] [dBm/dB] Enters lower point position.

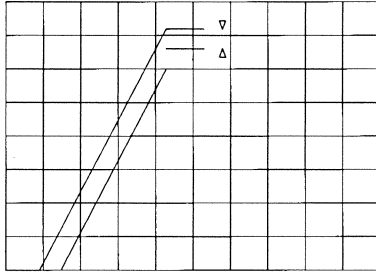

A single point limit is designated by two pointers. The upper limit points down, while the lower limit points up. The point limits are useful for testing the response of a device at specific test frequencies.

## Editing limit segments

To edit a segment, select [EDIT SEGMENT] from the limit line menu and enter the segment number, the segment will be cleared erasing any data. A segment may not be modified; mistakes may only be corrected if the units (i.e. GHz or dB) for that particular entry have not been selected yet, then the [BK SP] (backspace) key may be utilized to erase the entry. To delete segments, select [DELETE SEGMENT] or [DELETE ALL LNS] from the limit line menu.

## Creating limit lines for a bandpass filter

### Preset

Return the system to a known state, channel 1 active.

### Connections

Connect DUT as for insertion loss measurement.

## Controls

### Measurement

- [MEAS] [B/R]
- CHANNEL [2] Activates channel 2.
- CHANNEL [2] Turn channel 2 off, activates channel 1.

### Source parameters

- [CF] [10.24] [GHz]
- [ΔF] [2] [GHz]
- [POWER LEVEL] [10] [dBm/dB]

## Calibrate

Perform thru calibration.

## Save

After the limit lines have been created the setup should be saved again.

## Measure

Adjust trace for best data presentation.

- [SPCL]
  - [LIM LNS ON OFF]
  - [ENTER LIM LNS]
  - [FLAT LIMIT]
    - [8.24] [GHz]
    - [-55] [dBm/dB]
    - [ENT]
    - [9.6] [GHz]
    - [SLOPE LIMIT]
- } Enters the first segment from the table below.

The following table supplies the entries necessary to create the limit lines shown in the figure.

Seg	Type	Freq. (GHz)	Upper (dB)	Lower (dB)	Freq. (GHz)	Upper (dB)	Lower (dB)
1	FL	8.24	-55		9.6		
2	SL	9.6	-55		10.05	-1	
3	FL	10.17	0	-2	10.3		
4	SL	10.42	-1		10.9	-55	
5	FL	10.9	-55		11.24		

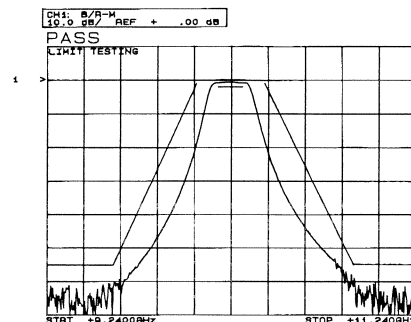



## Alternate sweep

The alternate sweep function of the HP 8350B sweeper and the HP 8340B/8341B and 8360 series synthesized sweepers was designed for use with HP scalar analyzers, utilizing the 8757 System Interface. This function provides the ability to make real-time measurements, alternating on successive sweeps between the source's current front panel state and any of the states stored in memory. Simultaneously, the device's response may be displayed over two independent frequency ranges or two different power levels.

When tuning a filter, there is an alignment tradeoff between passband ripple and out of band rejection. Real-time adjustments may be made by displaying the passband on one channel and the full filter response on another channel, as shown in the figure below. Amplifier manufacturers may compare small signal gain to large signal gain for real time 1 dB gain compression measurements.

The following lists important considerations for setting up alternate sweep measurements:

- Only the source settings (frequency and power) of channels 1 and 2 are successively changed, the current analyzer settings remain the same.
- The active channel is swept over the source's current front panel settings, while the other channel is swept over the alternate register's source settings.
- The measurement parameters (the information in the mode label area) of channels 1 and 2 in the active register, should be set up the same as that in channels 1 and 2 in the register with which the active register will be alternated.
- The analyzer settings, such as the number of points, AC/DC detection mode, adaptive normalization, etc. of the active register, must be the same as the analyzer settings of the register that will be alternated.
- To change the source or measurement parameters of a trace, select the desired channel to make it active. The source's front panel settings for that channel will now be displayed. Changing the source parameters of a calibrated trace will cause it to become uncalibrated unless adaptive normalization is activated prior to reducing the frequency span.
- Channel 1 should be the active channel of one storage register, channel 2 should be active in the other register.

The following sequence presents a simultaneous measurement of a filter's passband ripple and out-of-band rejection.

### Preset

Return the system to a known state, channel 1 is active.

### Connections

Connect DUT as for insertion loss measurement.

### Controls (Register 1)

Set up storage register 1.

Measurement

[MEAS] [B/R]  
CHANNEL [2] [MEAS] [B/R]

Source parameters

[CF] [10.24] [GHz]  
[ΔF] [2] [GHz]  
[POWER LEVEL] [10] [dBm/dB]

### Calibrate

With the HP 8757D, perform a thru calibration on channels 1 and 2, then follow the sequence below utilizing adaptive normalization.

When adaptive normalization is not utilized, channel 2 will require a thru calibration at the narrower frequency.

CHANNEL [2] Turns channel 1 off and activates channel 1

[SYSTEM] [ADPT NRM ON OFF]  
[SAVE] [1]

### Controls (Register 2)

Set up storage register 2. Only the source parameters are changed for this register.

Adaptive normalization is still on.

Measurement

CHANNEL [1] Turns channel 1 off and activates channel 2. Channel 2 is still set for B/R measurement.

Source parameters

[ΔF] [250] [MHz]  
[SAVE] [2]

# Measurement

Connect DUT.

[ALT n] [1] Alternates current display data stored in register 2, with the source parameters stored in register 1.

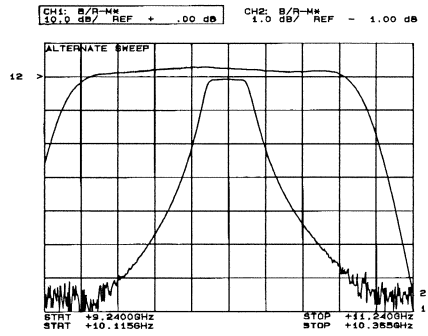

The traces should be scaled for optimal presentation of data. When the measurement is completed, pressing the [ALT n] hardkey again, will deactivate the alternate sweep function.

## External disk save/recall

**Note:** External disk drives for the HP 8757D are no longer available from Agilent.

Agilent 8757D-compatible disk drives are available from ISA, Inc. In the U.S., contact Saaya, Inc. (formerly known as ISA, Inc.). Elsewhere, contact ISA Company Ltd. at the following website: <http://www.isa-j.co.jp/>

Using the external storage capabilities of the HP 8757D facilitates greater productivity by allowing the user unlimited storage of measurement setups and data. Frequently used test setups may be easily recalled for use by numerous test station operators, ensuring consistent device measurement.

When secure measurement environments are necessary, the measurement may be stored externally without displaying any frequency annotation (frequency blanking is described in the following chapter). Test station operators may then utilize the prepared measurement parameters without requiring direct knowledge of the frequency settings.

This chapter describes how to set up the disk drive, initialize the disk, and utilize the external disk store and recall functions of the HP 8757D.

### Setting up the disk drive

When utilizing an external disk drive, the user must first set up the disk drive's HP-IB address, volume (for a hard disk drive), and unit number (for a floppy disk drive). Note that the HP 8757D can only access one drive at a time. The following sequence demonstrates the setup procedure.

#### Setting the disk's HP-IB address

- [LOCAL] [DISK] Accesses the address menu.
- [DISK] Displays the disk's current HP-IB address in the active entry area of the display; default address is 0.
- [#] [ENT] Sets the new address to #.

#### Setting the disk's unit and volume numbers

- [SAVE] Accesses the storage menu.
- [SET UP DISK] Accesses the disk menu.
- [DISK UNIT] Displays the current disk number in the active entry area; usually 0 is the default value for the hard disk or the left-hand drive on multiple disk units.
- [#] [ENT] Sets the disk unit to #.
- [DISK VOLUME] Displays the current volume number; floppy disk drives should have a volume number of 0, the default value.
- [#] [ENT] Sets the volume number to #.

## Initializing a blank disk

The HP 8757D provides the ability to initialize either a 3.5 inch floppy disk or a hard disk from the front panel. If the disk you wish to initialize is a 3.5 inch floppy, insert the disk into the appropriate disk drive prior to beginning this procedure.

**Note:** the following sequence will erase any information currently stored on the disk.

- [SAVE] Accesses storage menu.
- [SET UP DISK] Accesses disk menu.
- [INIT DISK] Sets up initialization.
- [INIT YES] Starts initialization.

## Save/Recall functions

The user may store parts or all of the information currently displayed, on an external disk. The [SAVE] and [RECALL] hardkeys offer a number of choices for saving or retrieving data (as shown in the following menus).

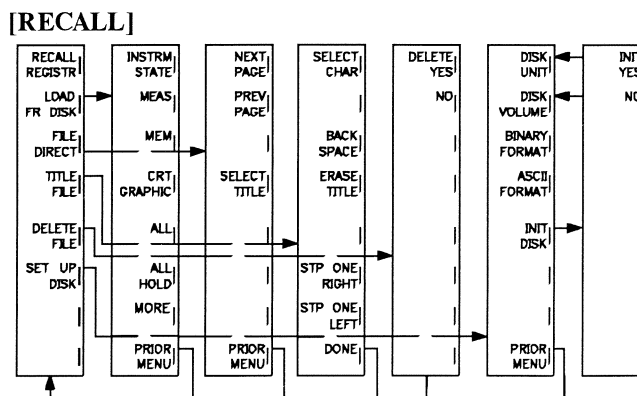
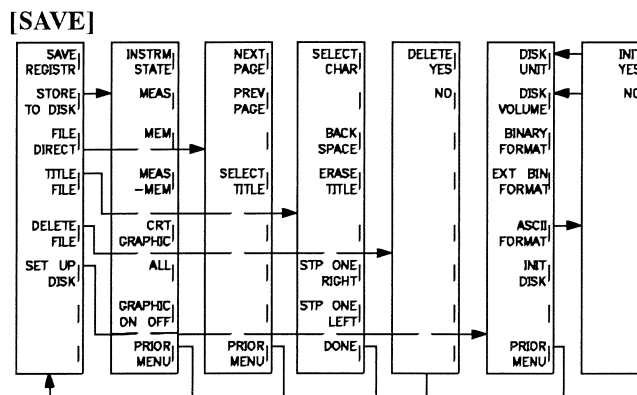

To store information on an external disk, each file must have a title with 8 characters or less. The **[TITLE FILE]** softkey is located in the **[SAVE]** and **[RECALL]** menus and uses the same title space as measurement titles. When selected, the name of the last file stored will be displayed in the title area. Following preset, the file title defaults to "FILE1."

When the file name has been entered, selecting **[STORE TO DISK]** allows the user to store all or part of the information currently displayed. Once stored, the information may be recalled at any time by selecting **[RECALL]** and **[LOAD FR DISK]**. If a title identifying the measurement was present prior to selecting the file name, when the file is recalled from the disk, the measurement title will reappear in the title area.

If a different file is required, the **[FILE DIRECT]** softkey displays a directory of all the files that have been stored on that particular disk. The HP 8757D displays the contents of each file by creating sub-files for the instrument state, trace data, trace memory, and CRT graphics. The file name associated with each of the sub-files is displayed on the left side of the screen (as shown in the example below). Selecting any of the sub-files accesses all or part of the file depending on what option is chosen from the **[LOAD FR DISK]** menu.

The following sequence demonstrates how to store and retrieve data using an external disk drive.

- [SAVE]** Accesses the storage menu.
- [TITLE FILE]** Accesses the title file menu.
- [ERASE TITLE]** Allows the entry of a new file name.
- [SELECT CHAR]** Selects the letter at the cursor on the display; use the front panel knob to move the cursor up and down the alphabet.
- [DONE]** Terminates the title selection process; returns the user to the save menu.
- [STORE TO DISK]** Initiates the external storage function.
- [ALL]** Stores all the displayed information; the user may choose to store only a portion of the current information by selecting one of the other options.
- [RECALL]** Accesses the recall menu.
- [FILE DIRECT]** Displays a directory of files stored on the disk.
- [SELECT FILE]** Selects the file title at the cursor; use the front panel knob to move the cursor up and down the file directory.
- [LOAD FR DISK]** Initiates the external recall function.
- [ALL]** Retrieves all of the file information; the user may choose to retrieve only a portion of the file by selecting another option.

TEST2A - ACTIVE FILE TITLE			NEXT PAGE
FILE TITLE	DESCRIPTION	NUM. OF POINTS	
TEST1A	BINARY Instrum State		PREV PAGE
TEST1A	BINARY Measurement Chan 1	401	
TEST1A	BINARY Measurement Chan 2	401	
TEST1A	BINARY Memory Chan 1	401	
TEST1A	BINARY Memory Chan 2	401	
TEST1B	BINARY Instrum State		SELECT TITLE
TEST1B	BINARY Measurement Chan 1	801	
TEST1B	BINARY Measurement Chan 2	801	
TEST1B	BINARY Memory Chan 1	801	
TEST1B	BINARY Memory Chan 2	801	
--▶ TEST2A	BINARY Instrum State		
TEST2A	BINARY Measurement Chan 1	1601	
TEST2A	BINARY Memory Chan 1	1601	
END OF DIRECTORY			
			PRIOR MENU

*Sample file directory*

# Special functions

## Color selection

One of the notable characteristics of the color selection function is the flexibility afforded the user to match his or her personal preferences. Each of the displayed notations such as the channel information, warnings and labels, as well as the grid and background may be adjusted individually. For those desiring a monochrome display, that is also available by the selection of a softkey.

Color selection is a global function, it is not affected by preset, or recalling a measurement from an internal storage register. When a file is retrieved from an external disk, the color selections stored in that file will be retrieved.

The display colors have been optimized to present the most pleasing and effective display. If the color selection must be changed, the HP 8757D allows quick modification via a color list menu. The color list provides access to 7 default colors (white, black, yellow, blue, salmon, red, and green).

All the color selection menus are accessed via the **[ADJUST DISPLAY]** softkey in the **[DISPLAY]** menu, as shown in the following layout of the color menus.

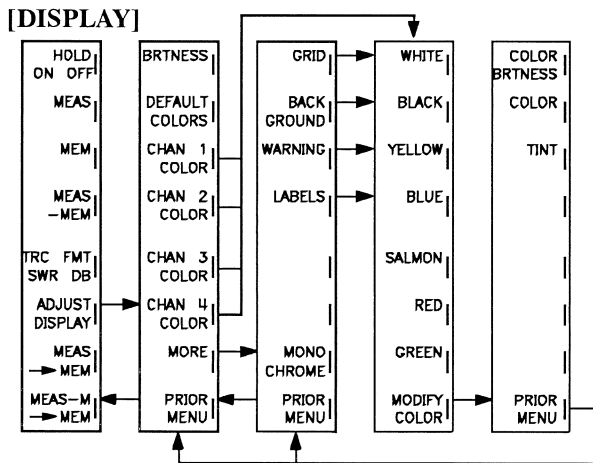

If the modification of the default colors is necessary, the user may select the **[MODIFY COLOR]** softkey at the bottom of the color list menu. It allows the user to change the color of a particular item (e.g. channel 1) by adjusting the tint, color and/or brightness.

In monochrome mode, the active trace is displayed with greater intensity than other traces. Once in monochrome mode, select **[ADJUST DISPLAY]**, then **[DEFAULT COLORS]** to reactivate the color mode.

## Frequency blanking

The frequency blanking function in conjunction with the 8757 System Interface, allows the user to operate the analyzer in a secure mode by deleting all frequency annotation on the analyzer and the source. Once the **[FRQ LBL OFF]** softkey has been selected from the **[SYSTEM]** menu, frequency annotation may not be reactivated until the instrument is preset. Storing information in the internal registers or on an external disk with frequency blanking enabled, guarantees that frequency blanking will still be active when it is retrieved, even if the analyzer was preset prior to the recall operation. The following sequence activates the frequency blanking function.

- [SYSTEM]**                      Accesses system menu.
- [LABELS]**                      Accesses labels menu.
- [FRQ LBL OFF]**              Deactivates frequency annotation on the analyzer and the source.

To disable the frequency blanking function, select **[PRESET]**.

## AC versus DC detection

There are two methods used to detect microwave signals for display and measurement with scalar network analyzers. AC detection uses a modulated RF signal, providing accurate and stable measurements by minimizing unwanted signals. DC detection, which utilizes an unmodulated RF signal is most useful for modulation-sensitive devices. This section describes the capabilities and advantages of each mode. For further information on AC/DC detection with scalar analyzers, refer to: Product Note 8757-1, "Using AC detection with the HP 8757 scalar network analyzers."

The AC detection mode uses a 27.778 kHz square-wave modulated source. The square wave is demodulated by the detector and only the modulated envelope is passed to the scalar analyzer. At the analyzer, the demodulated signal is AC coupled into the log amplifiers then digitized. There are four main benefits of AC detection in scalar network measurements: 1) broadband noise is rejected, 2) undesired RF signals are not detected, 3) thermal effects are minimized, and 4) fast sweep times are possible even at low power levels.

The DC detection mode does not require any source modulation, the detectors respond to all the signals present. The HP 85025, 85026, and 85037 series detectors operate in AC or DC mode. When the analyzer is in DC mode, the detectors chop the signal after detection to provide the 27.778 kHz signal that the analyzer processes. The receiver circuitry is identical in both modes. The HP 8757 DC detection process offers the speed advantage of AC detection, since the receiver is not limited by the settling time of the log amplifiers at low power levels. The following figure presents a comparison of the detection processes for AC and DC modes (1. AC detection, 2. DC detection).

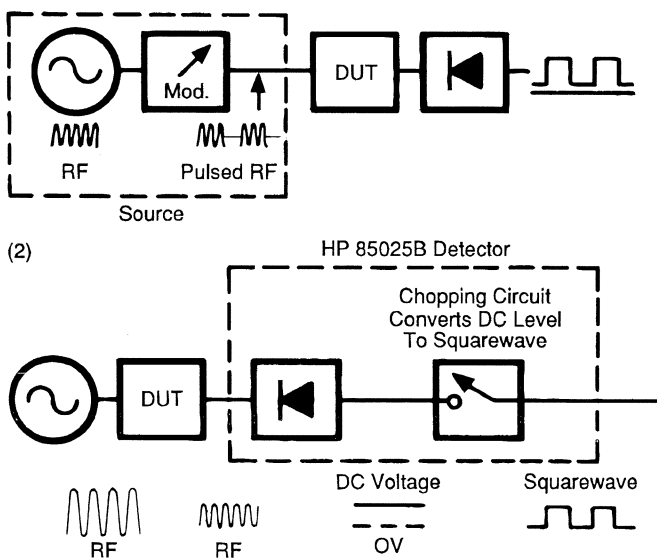

## AC detection

The HP 8757D receiver (the log amplifiers in the analyzer) effectively functions like a tuned AC voltmeter operating at 27.778 kHz. In many applications, such as measurement of high-gain limiting amplifiers, noise will be present along with the desired signal being measured. This type of interference can reduce the effective dynamic range of the measurement system by raising the noise floor. In AC detection mode the analyzer is sensitive only to the signals that have the appropriate square wave modulation. Since only the desired signal is modulated at the source, the noise and other non-modulated RF signals are ignored, resulting with a true representation of the performance of the device under test.

Temperature changes can have a dramatic effect on measurements in DC mode, since they may induce a DC voltage offset at the diode's output. AC detection minimizes this problem by measuring only the modulated RF signal, thus ignoring the DC offset. Detector sensitivity to thermal change is a primary concern when measuring device performance as a function of temperature, particularly at low power levels (less than -40 dBm).

AC detection is the best broadband measurement technique for mixer testing. The presence of high-level LO feedthrough at the IF port of the mixer under test will impact the accuracy and dynamic range of the scalar analyzer, if DC detection is used. When the analyzer is operated in AC detection mode, the effect of the LO feedthrough is minimized by modulating the RF signal and leaving the LO signal un-modulated, thus the detector will respond only to the modulated IF.

## Using DC detection

Certain devices require DC detection mode for the best results. Amplifiers with automatic gain control (AGC) are adversely affected by the modulation in AC detection mode. The leveling circuitry unsuccessfully tries to adjust the gain to track the modulation, the resulting square wave is distorted, degrading the scalar analyzer response. Other modulation sensitive devices include: amplifiers with slow responding self bias, devices with high gain at very low frequencies (<1 MHz), and devices with very narrow bandwidths (<1 MHz).

Absolute power (dBm) measurements may be more accurate in DC detection mode, since the measurement is not subject to variations in source modulation. Also, DC mode is more easily referenced to a power meter; in AC mode the power meter reading would be nominally 3 dB lower than the scalar analyzer reading, due to the square wave modulation of the source.

## Symbols

*[ADJUST DISPLAY]*, 25  
*[AUTOSCALE]*, 7  
*[AVG]*, 13  
*[CLEAR SAV/RCL]*, 7  
*[CURSOR]*, 8, 12  
*[DEFINE CUSTOM]*, 9  
*[DISPLAY]*, 25  
*[ENT]*, 4  
*[GRAPH COLOR]*, 9  
*[GRAPH MONO]*, 9  
*[LABELS]*, 9  
*[MAX]*, 12  
*[MEAS]*, 5  
*[MEAS-MEM]*, 7  
*[MIN]*, 12  
*[MODIFY COLOR]*, 25  
*[PLOT CUSTOM]*, 9  
*[PLOT]*, 8  
*[POWER CAL]*, 6  
*[PRINT MARKERS]*, 9  
*[PRINT]*, 8  
*[RECALL]*, 7, 23  
*[REF LEVEL]*, 11  
*[REF POS'N]*, 11  
*[REF]*, 11  
*[SAVE]*, 7, 23  
*[SCALE TO P1P2]*, 9  
*[SCALE]*, 7  
*[SPCL]*, 14, 19

## A

Absolute power calibration, 6  
 AC/DC detection, 26  
 Active channel, 3  
 Active devices, 15  
 Active entry area, 3  
 Alternate sweep, 21  
 Aperture, 14  
 AUX, 7  
 Averaging, 13

## B

Bandwidth, 3 dB, 12  
 Basic system configuration, 5

## C

Color selection, 25  
 CRT display, 3

## D

Data entry, 4  
 Default colors, 25  
 Default Conditions, 5  
 Device termination, 17  
 Disk setup, 23  
 Display menu, 3

## E

External storage, 23

## F

Frequency blanking, 25  
 Front panel, 3  
 Function keys, 3

## G

Gain compression, 15  
 General measurement sequence, 4

## I

Initializing a blank disk, 23  
 Insertion loss, 11  
 Instrument State keys, 4

## L

Limit lines, 19

## M

Marker, 14  
 Markers, source, 8  
 Measure device under test, 7  
 Measurement accuracy, 17  
 Mode labels, 3  
 Monochrome mode, 25

## N

Noise reduction, 13

## O

Optimizing dynamic range, 12  
 Optimizing trace display, 7  
 Out of band rejection, 12  
 Output power, gain measurements, 15  
 Output results, 8

## P

Peak-to-peak ripple, 12  
 Preset, 4, 5

## R

Reflection measurement calibration, 7  
 Reflection measurements, 17  
 Return loss, 18

## S

Signal separation, 17  
 Smoothing, 14  
 Status notations, 3  
 Storing information externally, 23  
 Storing information internally, 7  
 SWR, 7, 18

## T

Transmission measurement calibration, 6

## U

u – uncalibrated, 14

## W

Window, smoothing, 14